

FRAMELESS BASE CABINET

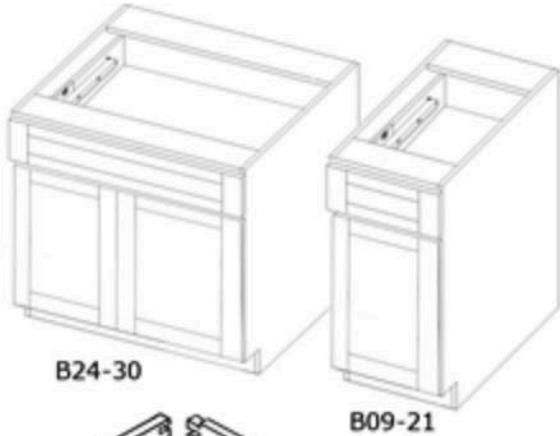

CABINET COMPONENTS:

- A Right Side Panel
- B Top Front Panel
- C Bottom Panel
- D Top back Panel
- E Back Support (Upper & Lower)
- F Back Panel
- G Shelves
- H Toe Kick
- I Left Side Panel
- J Door Panel

HARDWARE:



DRAWER COMPONENTS:

- A1 Left Side Panel
- B2 Right Side Panel
- C3 Bottom Panel
- D4 Back Panel
- E5 Front Panel

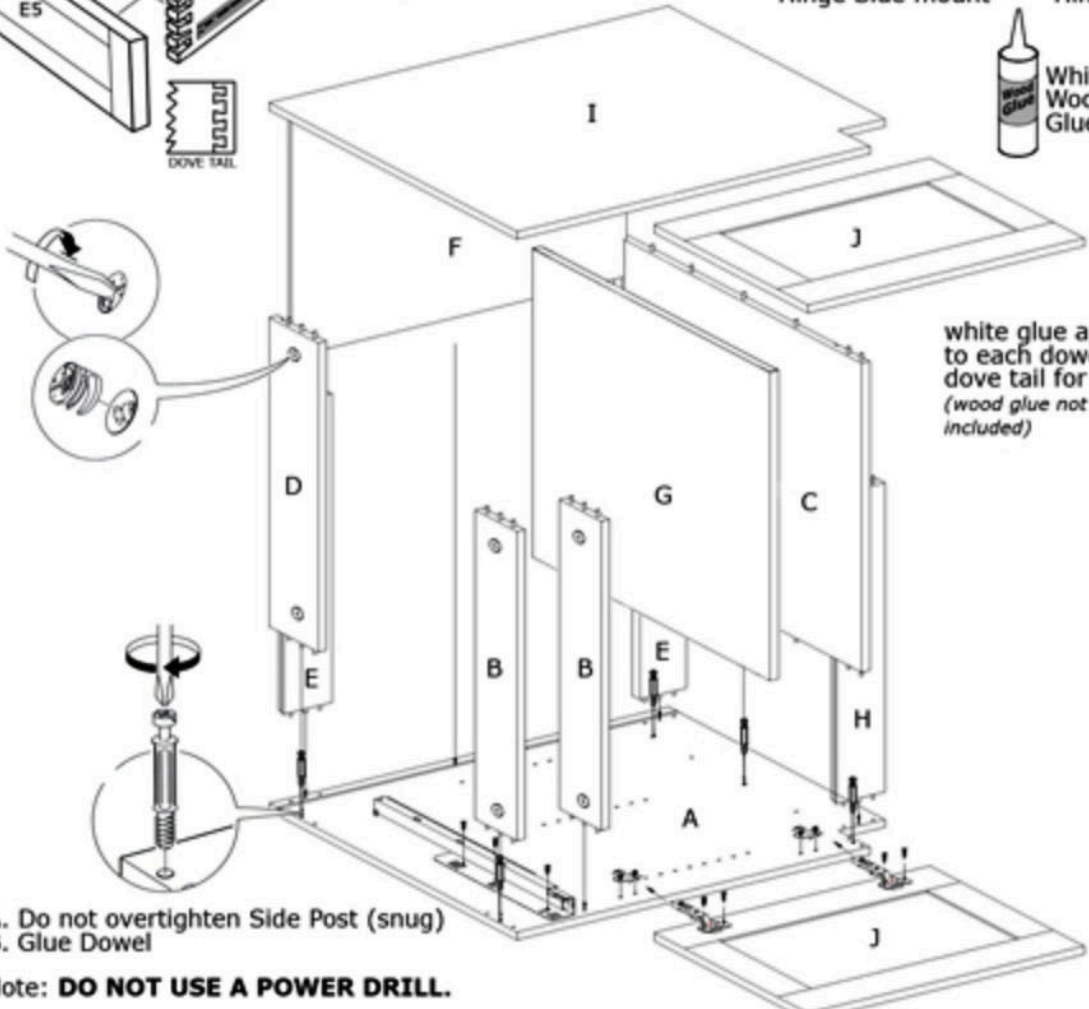
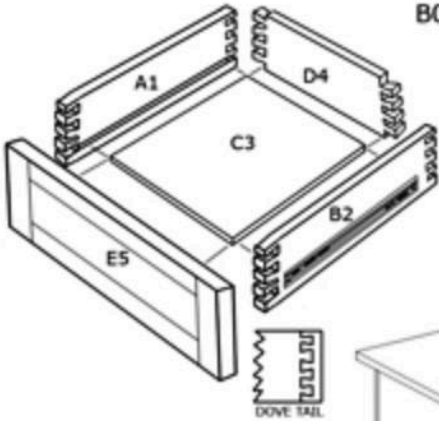

white glue applied to each dowel and dove tail for stability (wood glue not included)

- A. Do not overtighten Side Post (snug)
- B. Glue Dowel

Note: **DO NOT USE A POWER DRILL.**

BASE CABINET

1

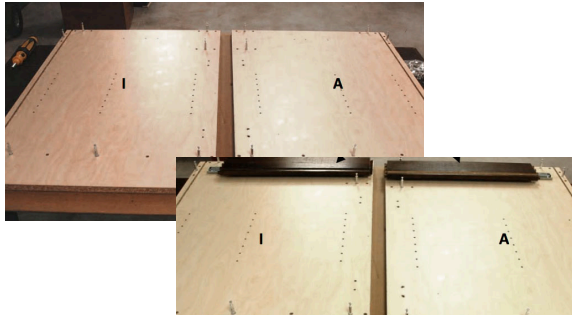

- Lay sides I & A (left & right side panel) face down so the holes show
- Insert side posts to plastic holders
- The height of the pins should be 1 ¼” from the flat surface
- Attach drawer slides (A1 & B2) to I & A

2



- Align the pre drilled pilot holes up with the slides and level your drawer
- The last pilot hole on the right will line up your fill extension drawer

3

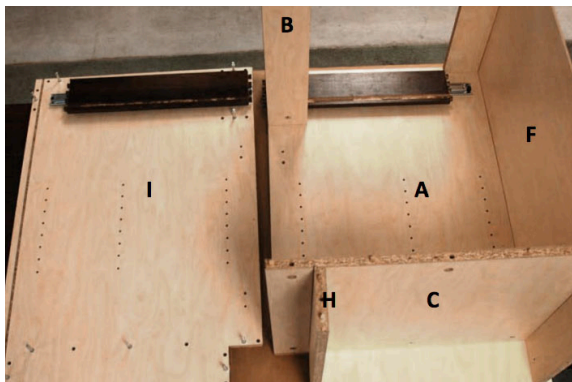

- Attach the following pieces to side A and cam lock into place:
- Insert C (bottom panel) to bottom of A
- Attach H (toe kick) groove up to front left corner underneath C
- E (back lower support) to back left corner underneath C
- E (back upper support) & D (top back panel) to top right corner, the grooves will connect together
- Slide in F (back panel) to D and C
- Attach the 2 B's (support panels) above & below your slide

4

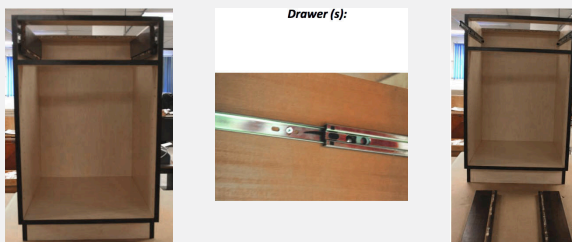

- Now attach piece I to the dowels showing
- You now have a box unit, stand up for easier access when inserting drawer(s) and door(s)
- Detach A1 & B2 from A & I sliders come off using back clip attached to slider (left side push up, right side push down) and then pull drawer slides out until drawer is free)

BASE CABINET

5

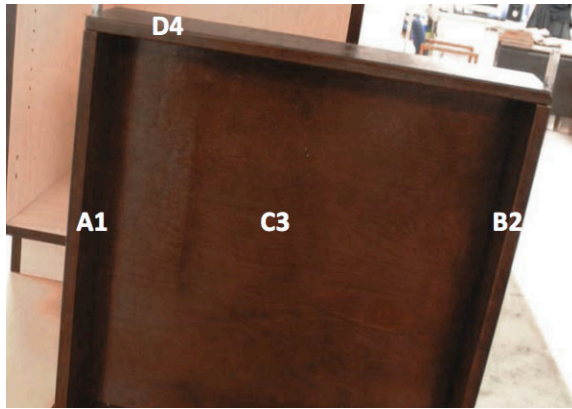

- Lay E5 (front panel) face down so the groove shows
- Place a small glue line into groove and insert C3 (bottom panel)
- Attach A1 & B2 to C3, dove tails will line up, again place a small glue line into each groove
- Knock into place for a snug fit
- Lastly apply D4 (back piece) to dove tails, glue and knock into place
- Let glue dry
- After drawer(s) are put together and glued, line up drawer slides and push back into box unit

6



- Place door face down
- Insert hinges into circle cut outs
- Screw into place
- Attach door to A (and or I) to make either a left open or right open cabinet (screws are already on hinges for easy assembly to the carcass)

7



- Insert shelf using the 4 supports included
- Shelf height is adjustable

8



- Lastly adjust the door(s) if need be by tightening or loosening hinge screws
- Adjust the screws that aren't connected to either the carcass or door to the left, right, front and back